

Assembly Instruction

A  SCREWS 3.5*35 18PCS
 B  SCREWS 3.0*25 32PCS
 C  SCREWS 3.5*50 16PCS

D  SCREWS 3.0*28 6PCS
 E  SCREWS 3.0*16 12PCS
 F  LATCHES 2PCS

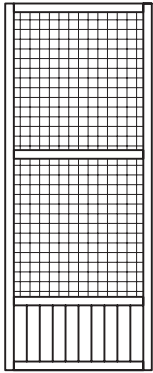

① × 4

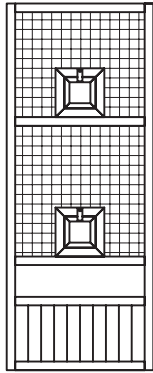

②

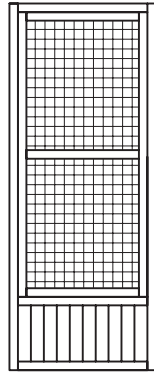

③

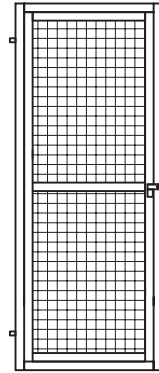

④



⑤

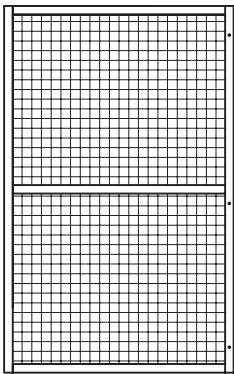

⑥

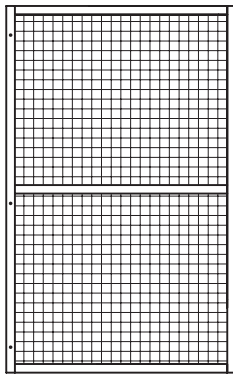

⑦

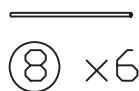

⑧ × 6

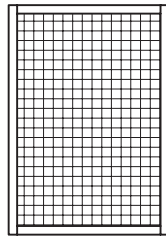

⑨

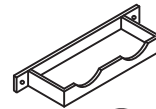

⑩



⑪

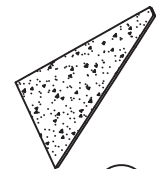

⑫ × 3

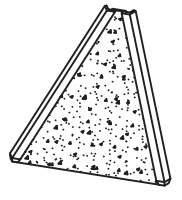

⑬ × 3

1

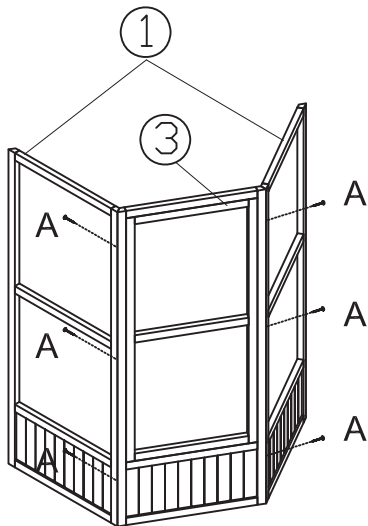

A  × 6

2

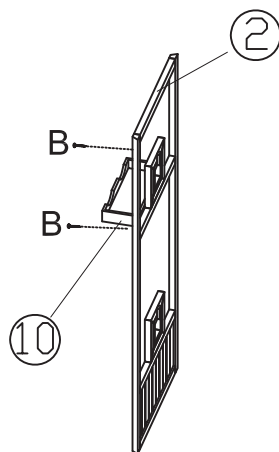

B  × 2

3

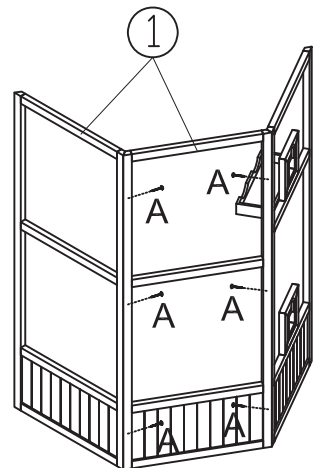

A  × 6

Assembly Instruction

4 A → x 6

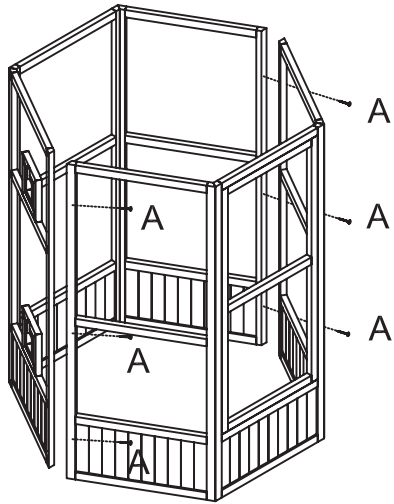

5 B → x 16

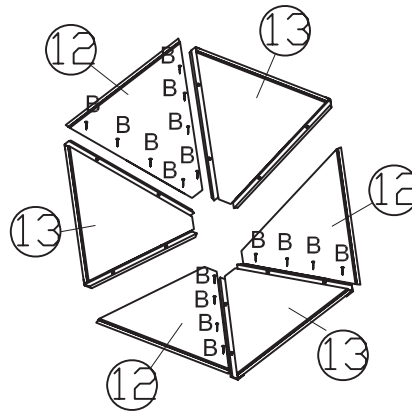

6 B → x 8

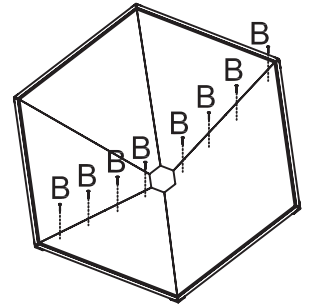

7 B → x 6

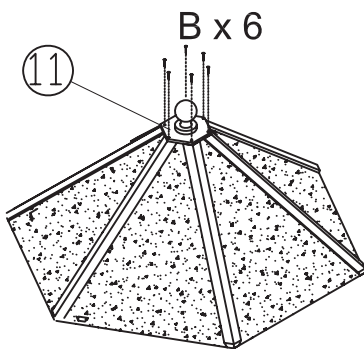

8

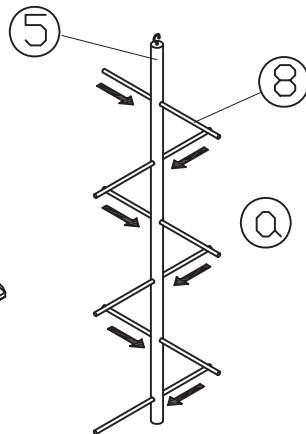

9 D → x 6

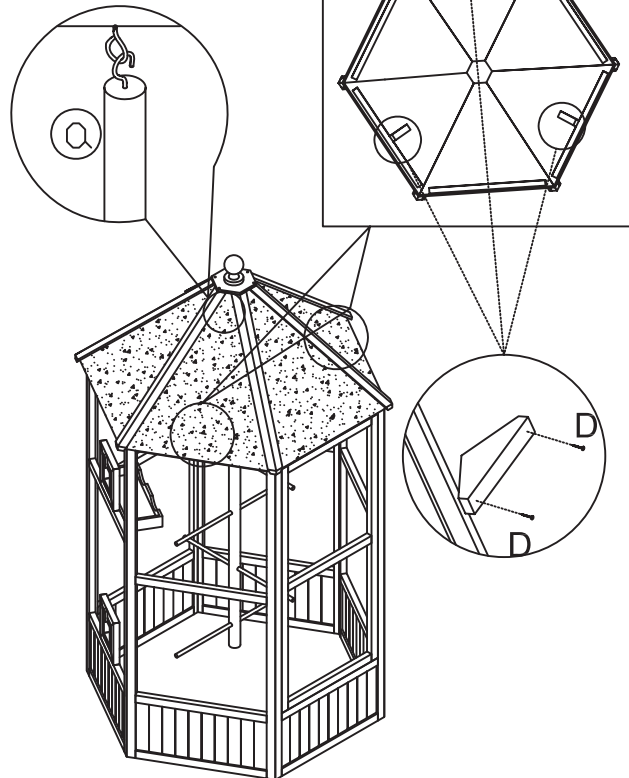

10

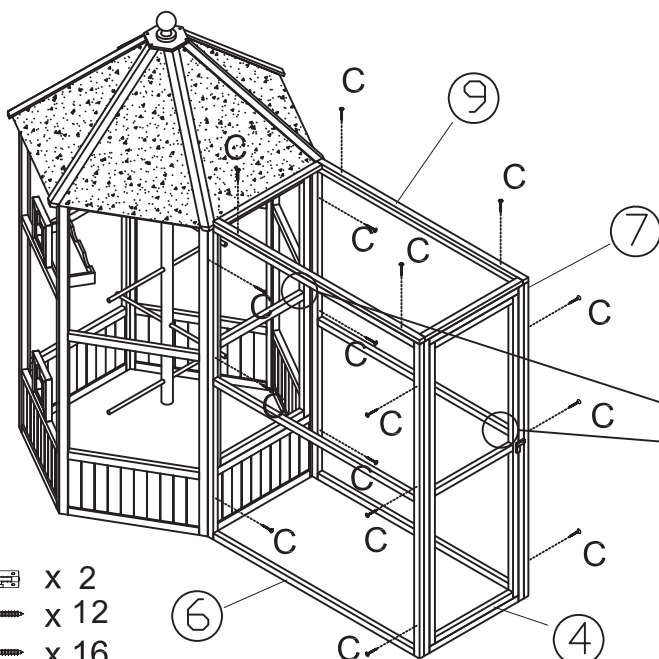

F → x 2
E → x 12
C → x 16

